

Portfolio

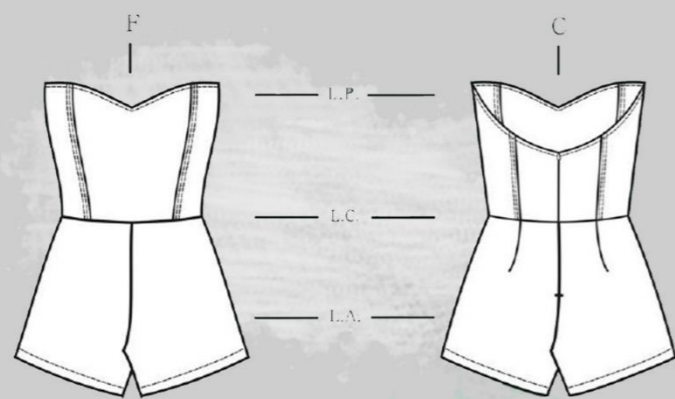

Inês Sanches

Exponoivos Contest

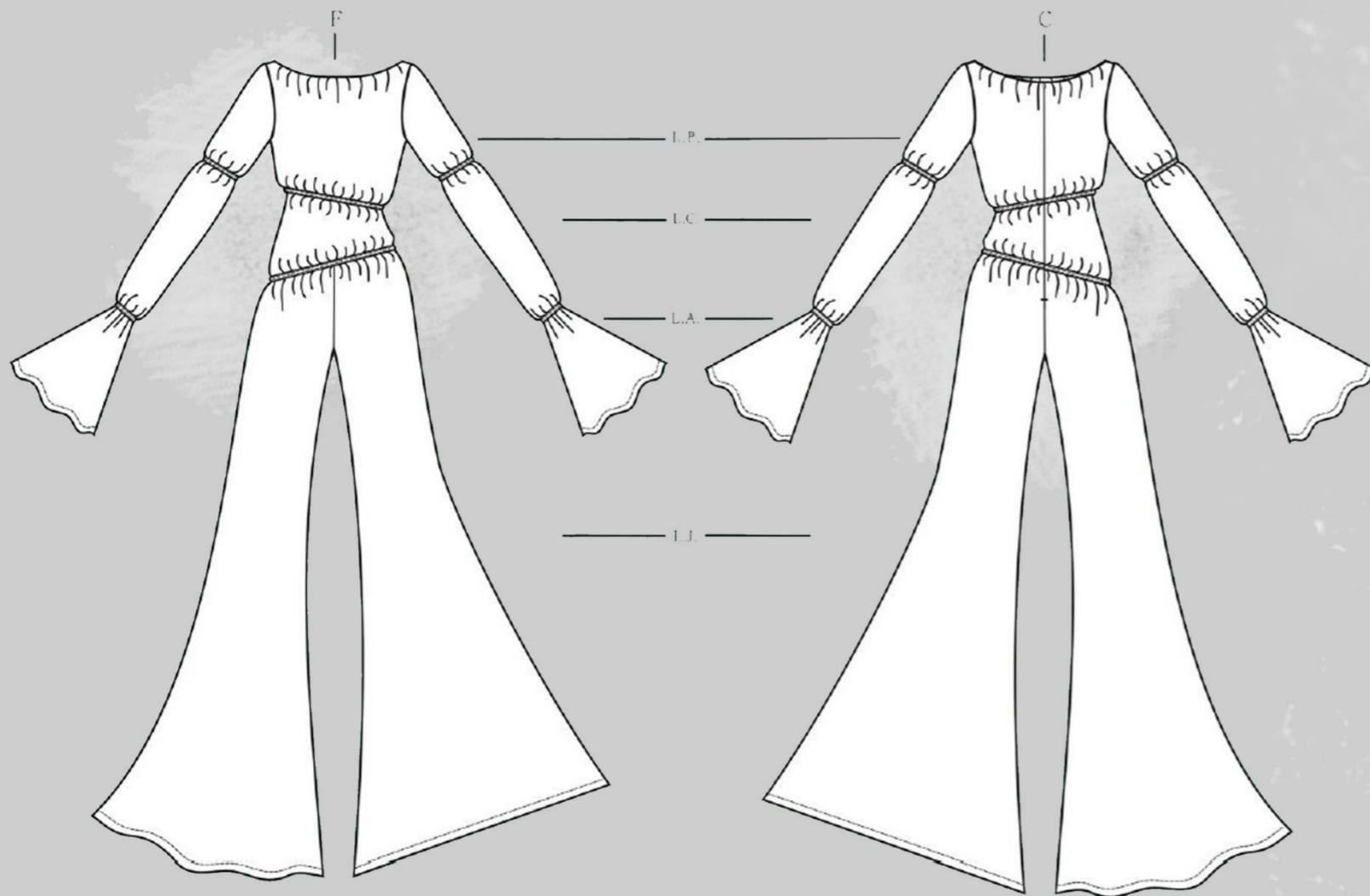

JEANSWEAR



Art in Fashion

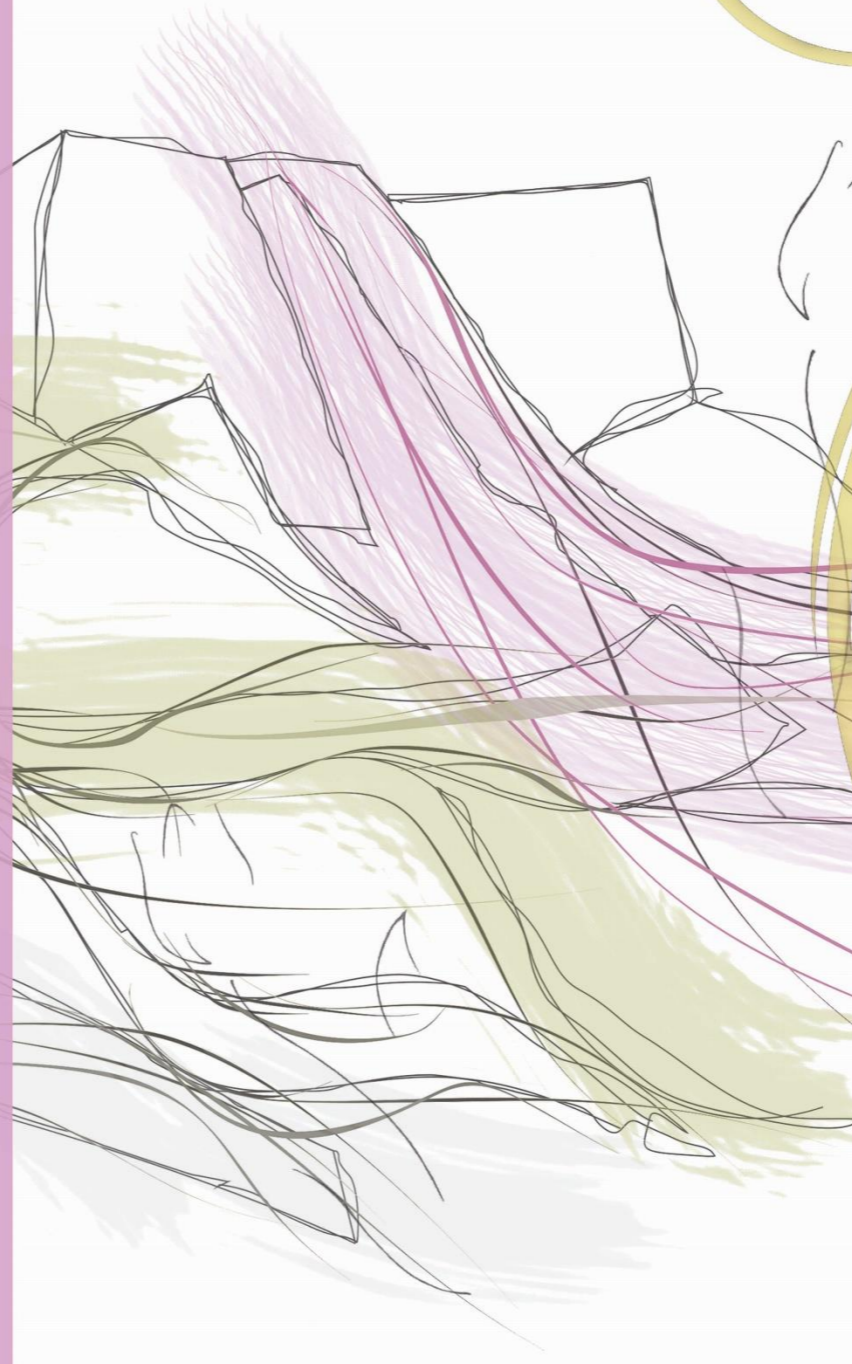
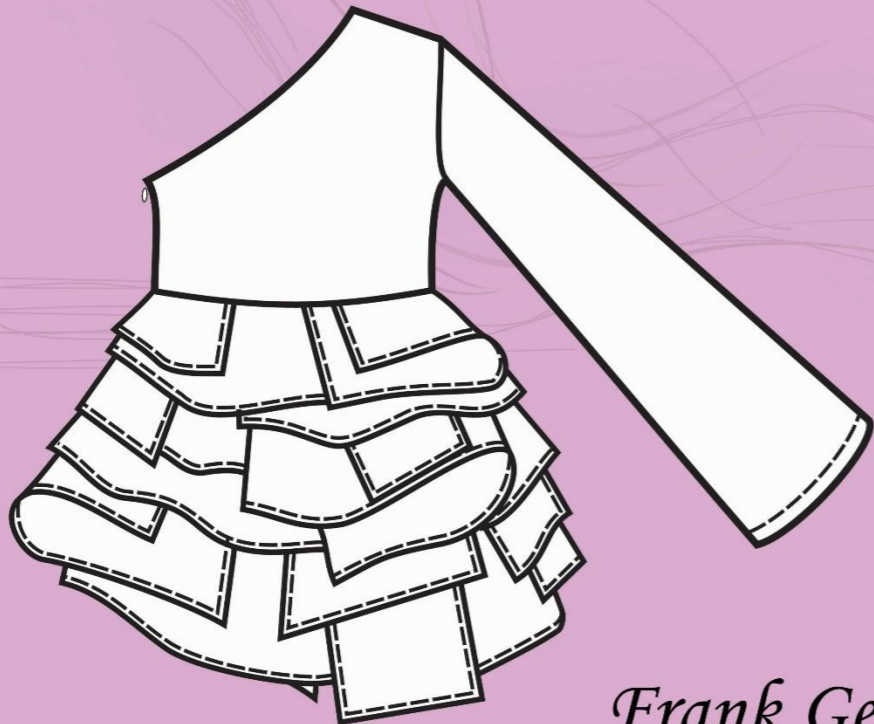
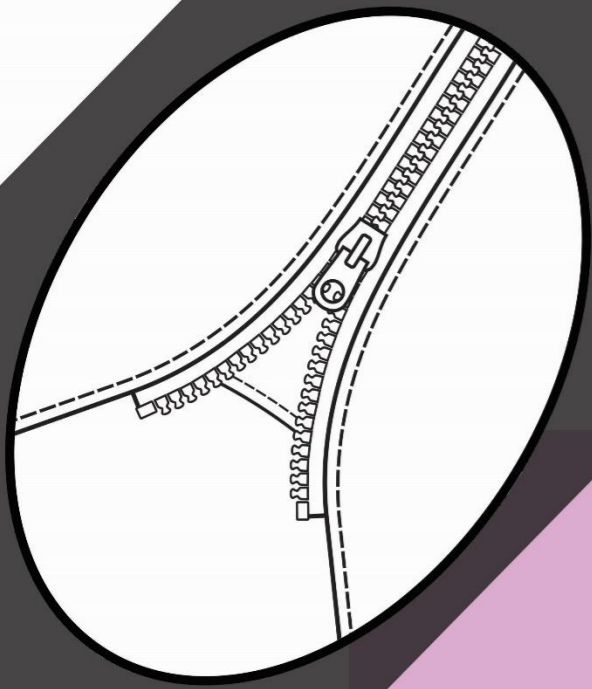

Frank Gehry, Hotel Marqués de Riscal

Nature Hour

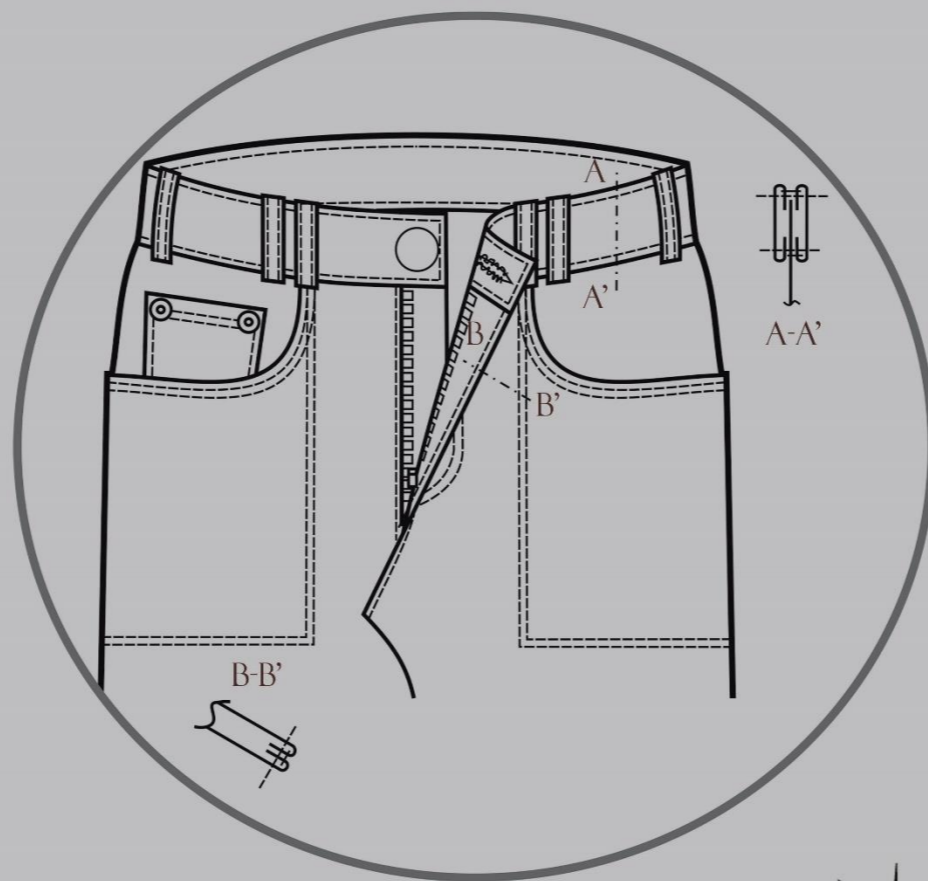
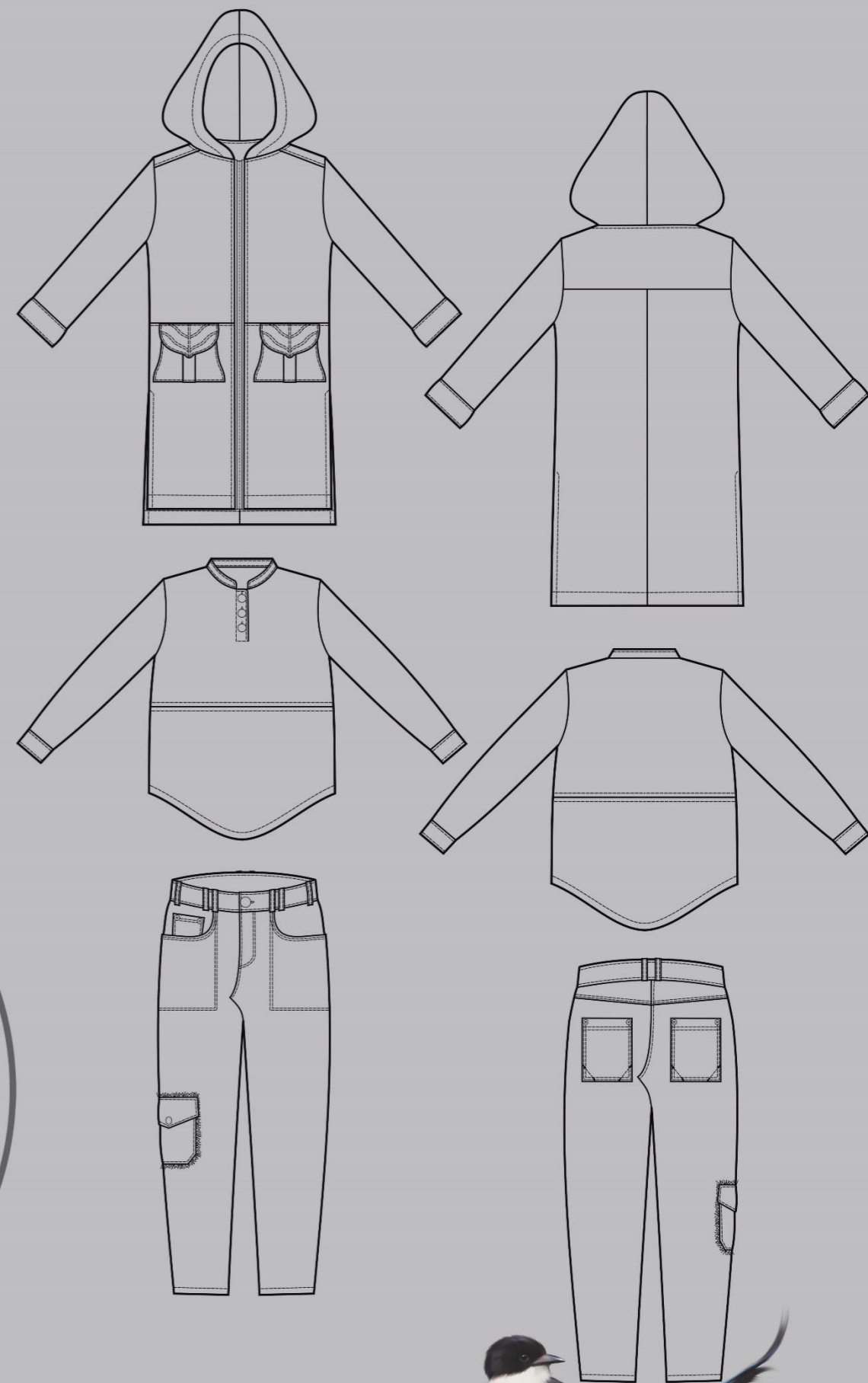

Nature Hour

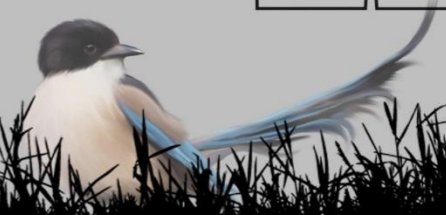
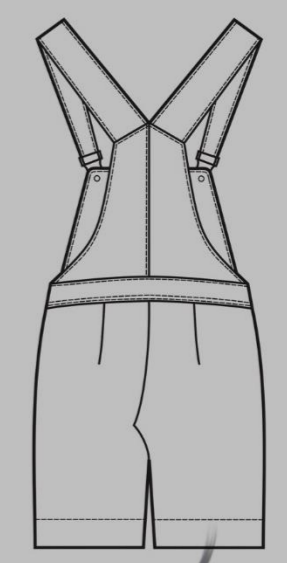
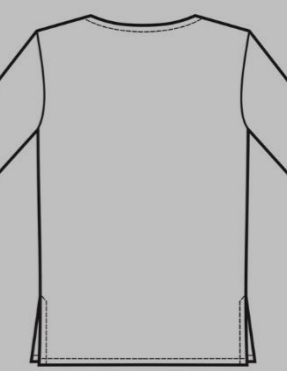
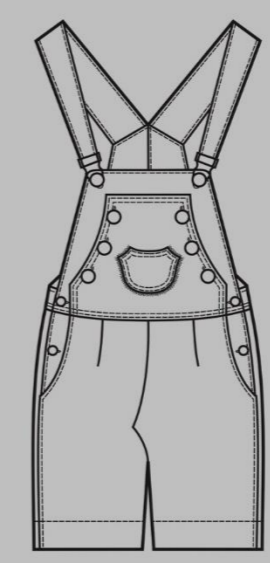
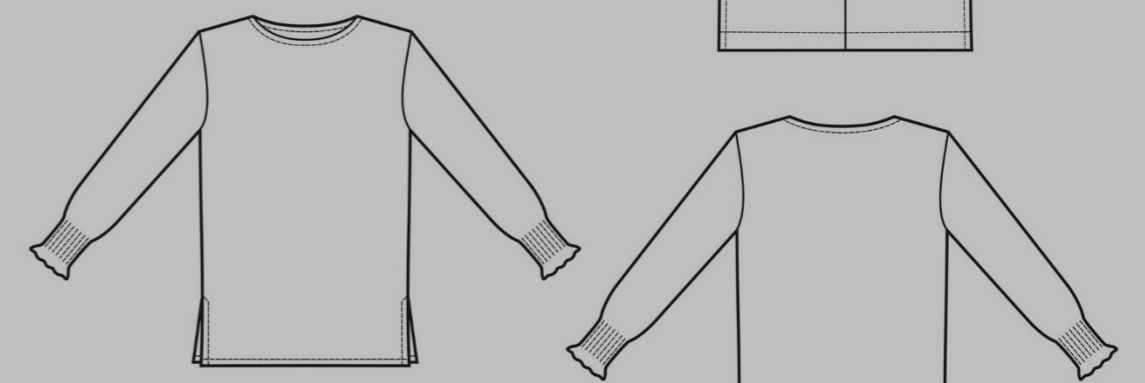
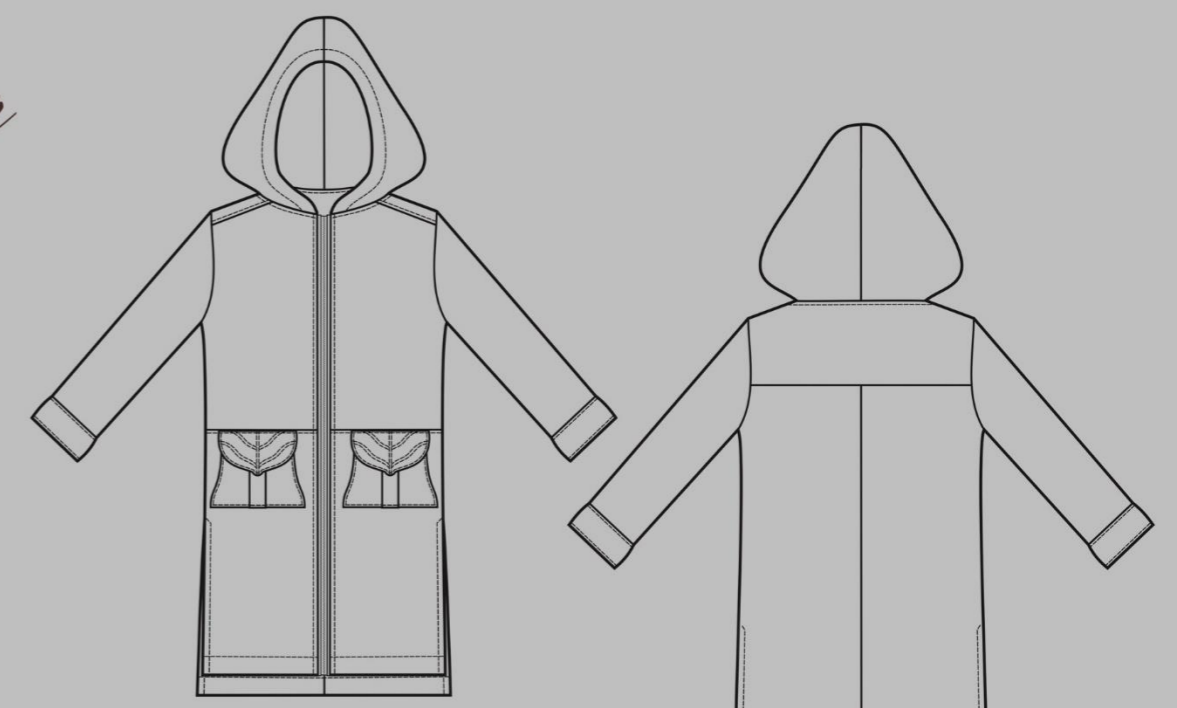
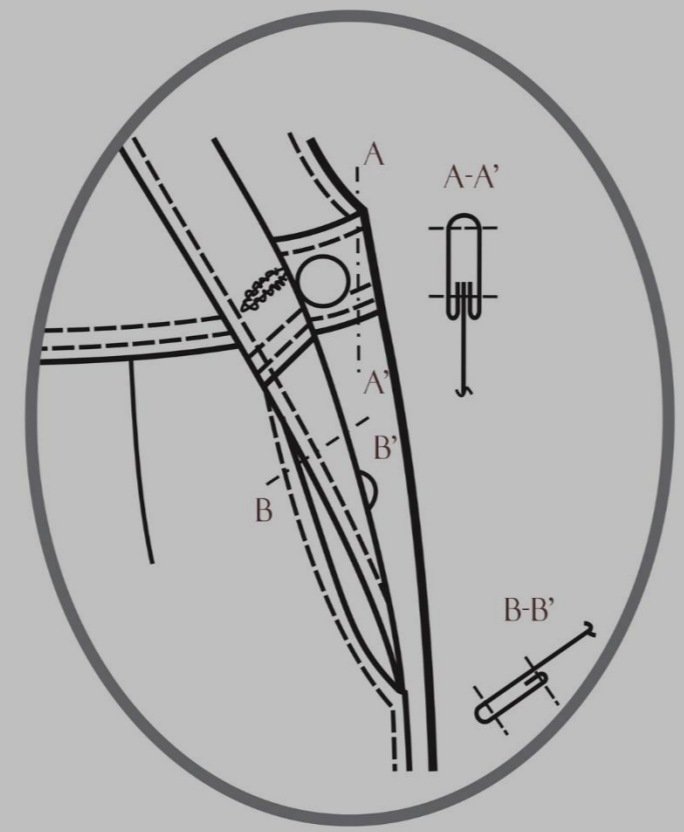
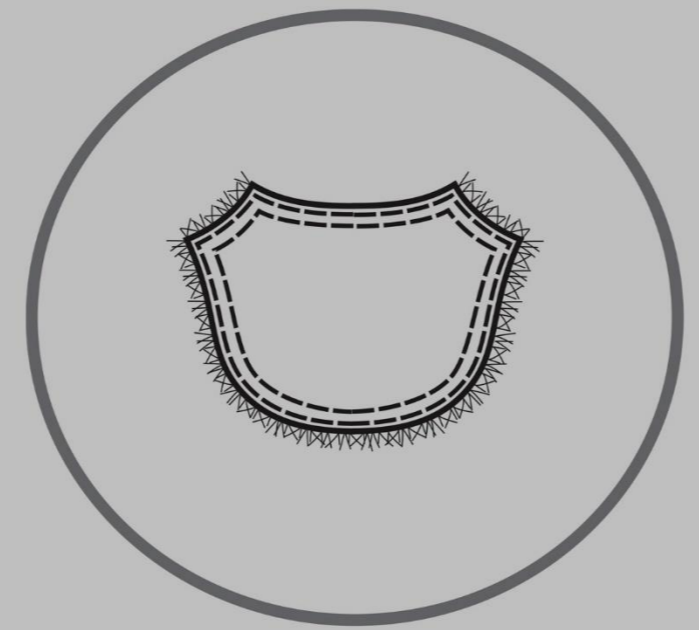

Paratissima Contest



Inês Sanches
Julia Serrano





Namorar Portugal Contest

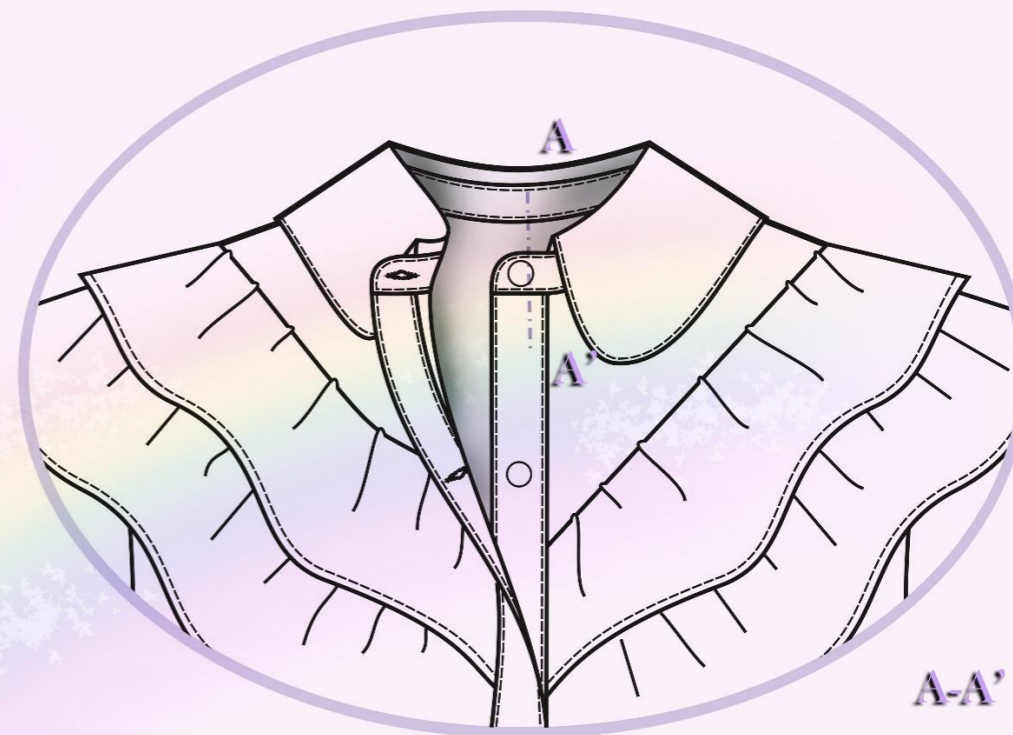

A-A'

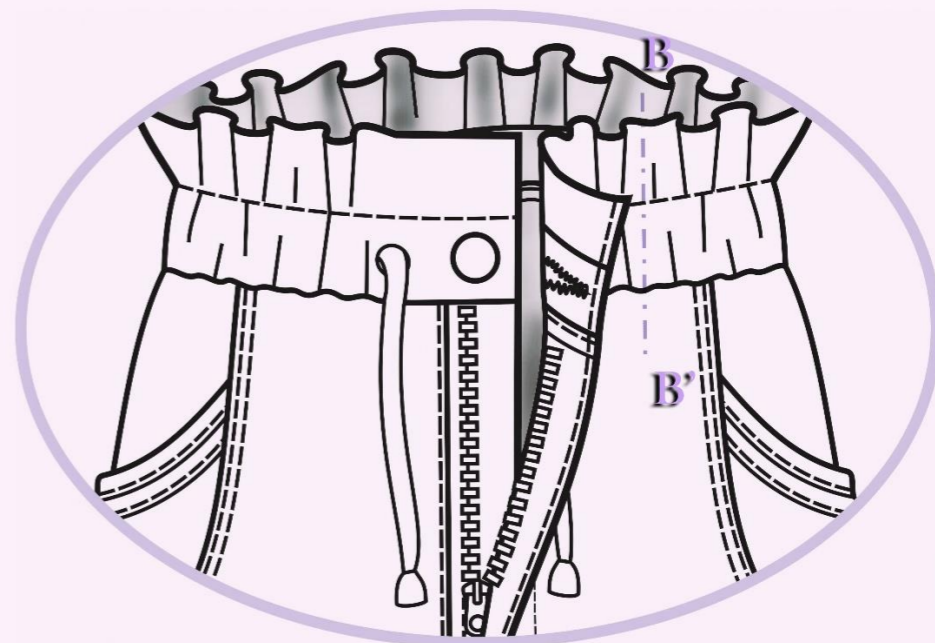
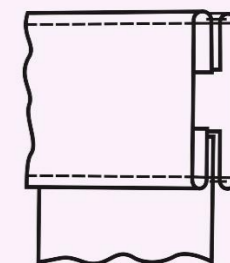

B-B'

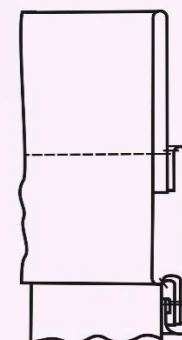



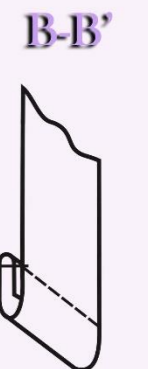
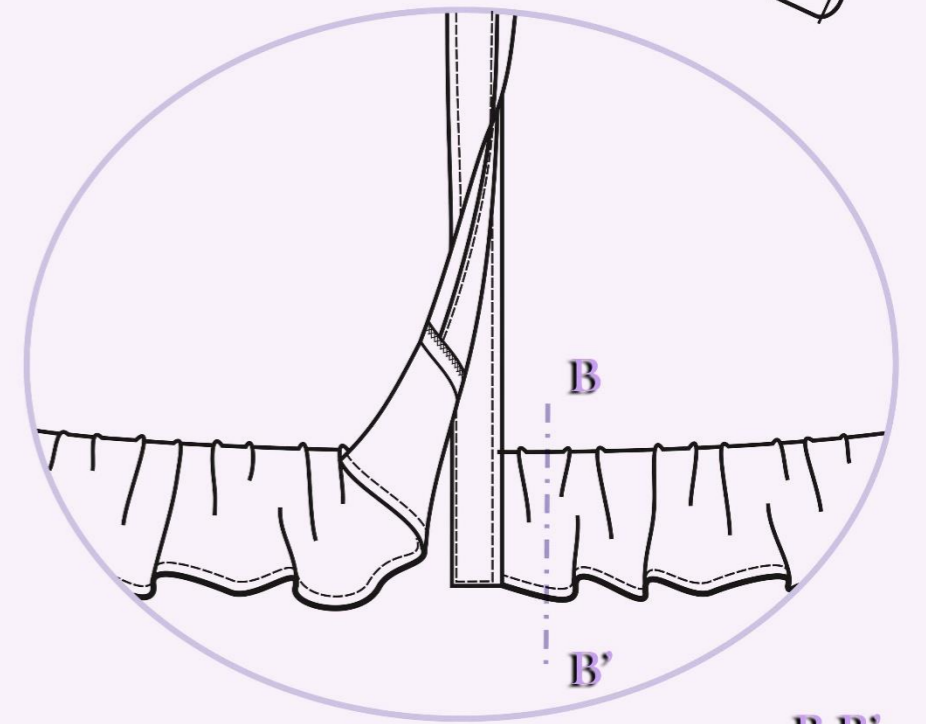
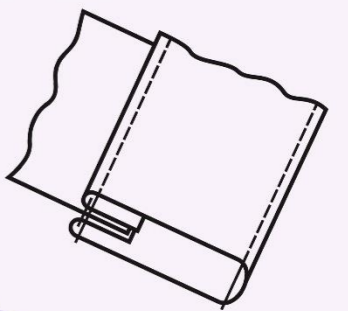
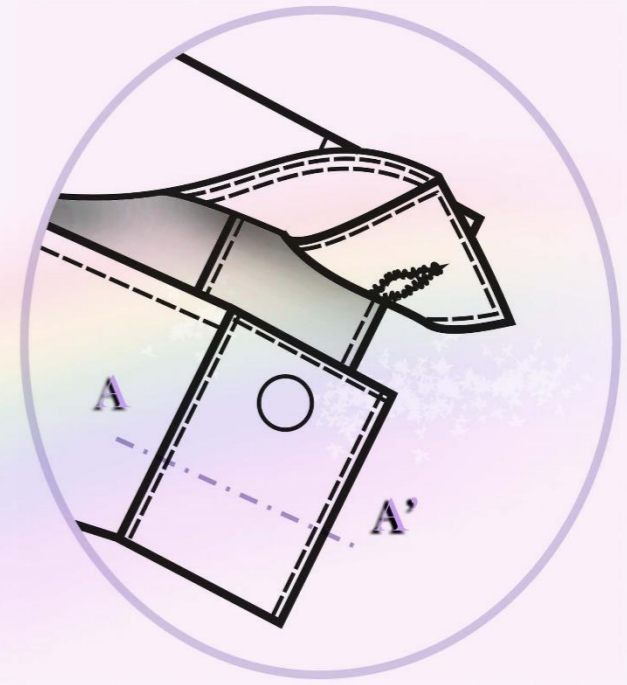

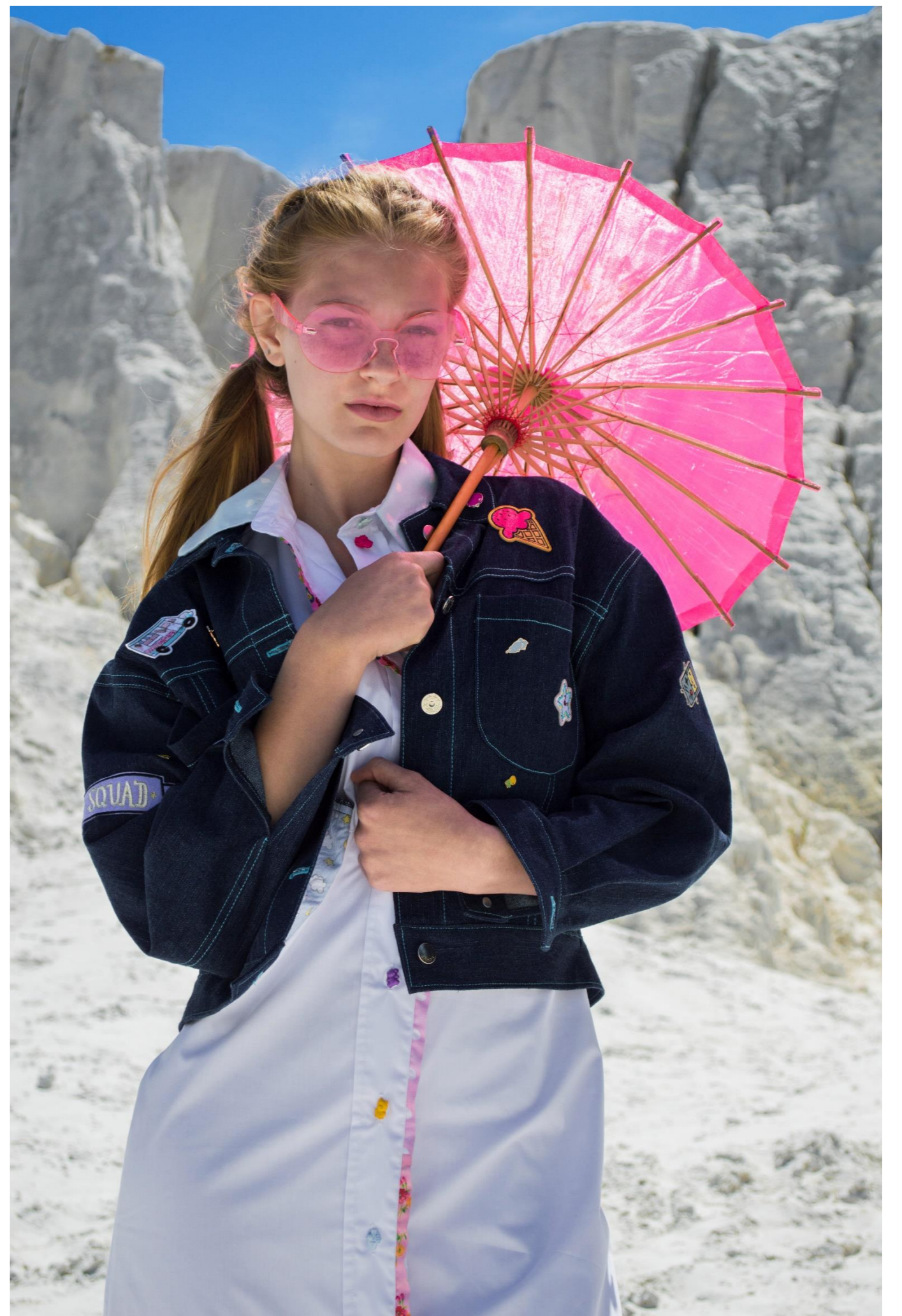

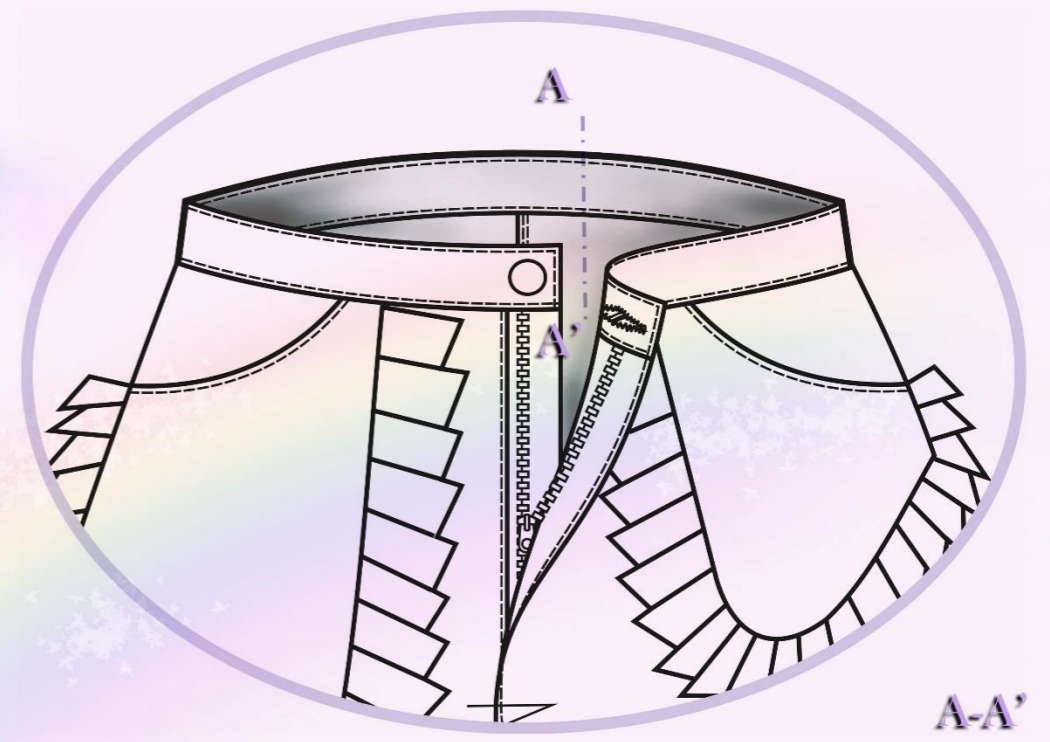
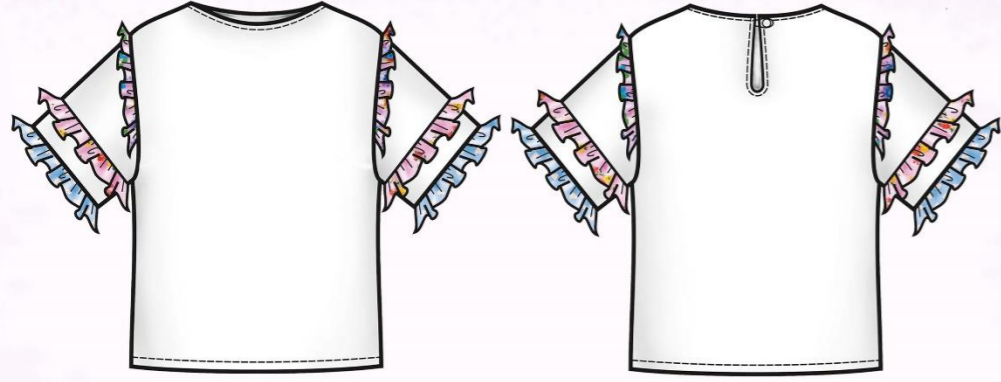

A-A'

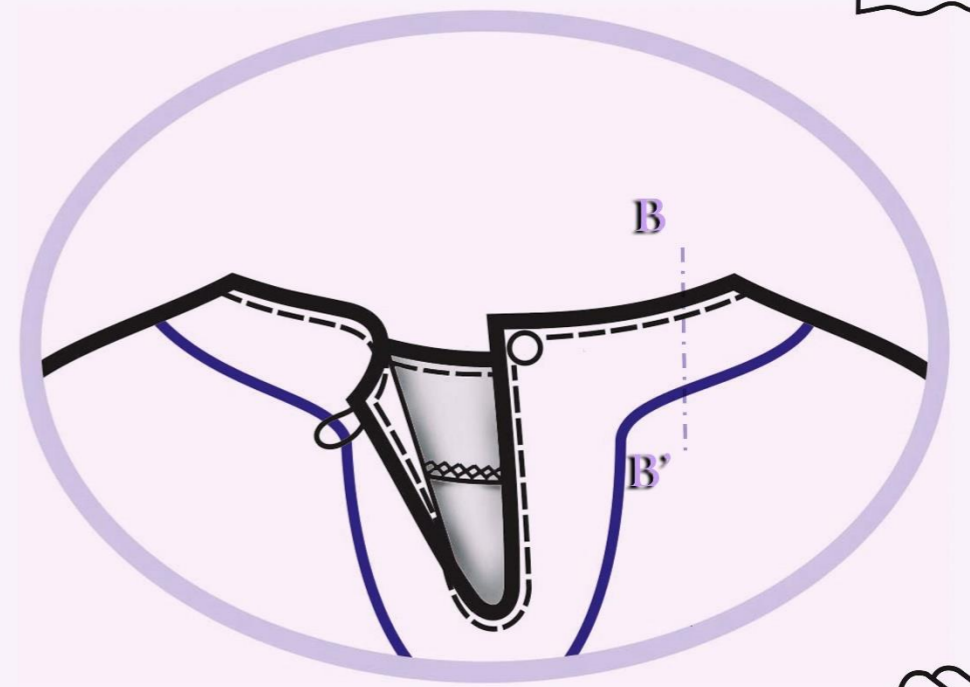
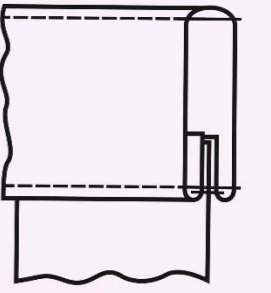

B-B'

